

(Please refer to the *Motion Coordinator* Technical Reference Manual 7 for Full Details)

BACKLIT DISPLAY

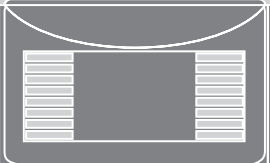

ETHERNET PROGRAMMING



SD CARD



I/O, CAN, POWER, ANALOGUE



RS232 + RS485



SYNC ENCODER



FIRST EXPANSION MODULE



## I/O CONNECTOR

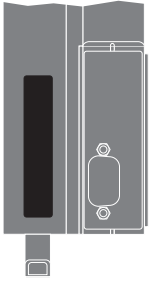

0V AIN		0V CAN/AIN
AIN0		CAN LOW
AIN1		CAN EARTH
WDOG+		CAN HIGH
WDOG-		24V CAN/AIN SUPPLY
I 0		I/O8
I 1		I/O9
I 2		I/O10
I 3		I/O11
I 4		I/O12
I 5		I/O13
I 6		I/O14
I 7		I/O15
0V I/O		24V I/O SUPPLY
0V SUPPLY		24V SUPPLY

The bottom 2 pins of the 30 way high density input connector are used to provide the 24V dc power to the MC464. A 24V dc, Class 2 transformer or power source must be provided.

The 2 pins above the 24V dc supply are to power the I/O 24 Volts.

*The MC464 is grounded via the metal chassis. It MUST be installed on an unpainted metal plate or DIN rail which is connected to earth.*



## RJ45 CONNECTOR (TOP)

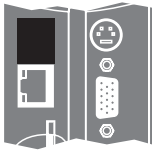

A standard ethernet connector is provided for use as the primary programming interface.

The Trio programming software, *Motion Perfect 2 or 3*, must be installed on a Windows based PC that is fitted with an Ethernet connection. The IP address is displayed on the MC464 display for a few seconds after power-up or when an Ethernet cable is plugged in.

## SERIAL CONNECTIONS

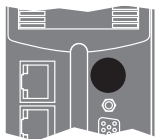

### 8 Way MiniDIN

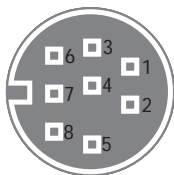

Pin	Function	Note
1	RS485 Data In A Rx+	Serial Port #2
2	RS485 Data In B Rx-	
3	RS232 Transmit	Serial Port #1
4	0V Serial	
5	RS232 Receive	Serial Port #1
6	Internal 5V	
7	RS485 Data Out Z Tx-	Serial Port #2
8	RS485 Data Out Y Tx+	

## SYNC ENCODER CONNECTIONS



### 9 Way D-Type

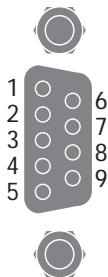

Pin	Encoder	Pulse & Direction
1	Enc. A	Step +
2	Enc. /A	Step -
3	Enc. B	Direction +
4	Enc. /B	Direction -
5	0V Encoder	0V Stepper
6	Enc. Z	Enable +
7	Enc. /Z	Enable -
8	5V*	5V*
9	Registration Input (5V)	Registration Input (5V)

\* 5V supply is limited to 150mA.

## ADDING EXPANSION MODULES AND BATTERY

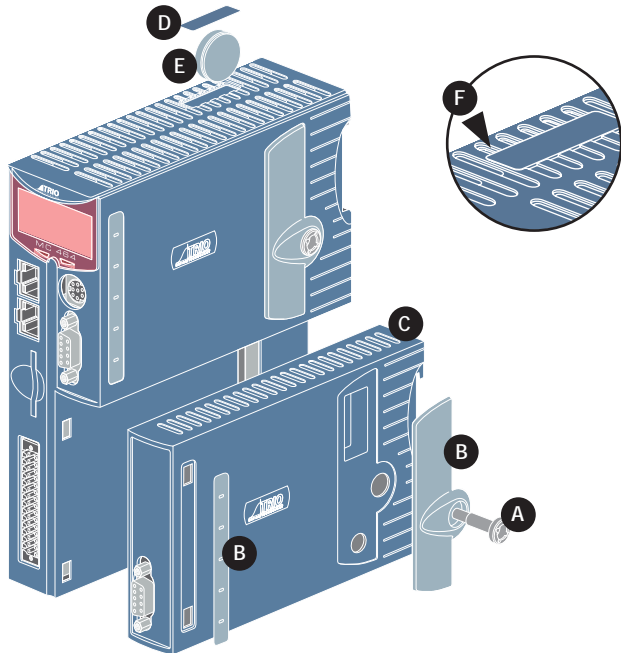

Unscrew the lower retaining fixing (A) using the supplied tool or a coin.

Remove the covers from the module (B).

Swing the expansion module (C) out from the rear and unclip from the front end.

Replacing the module is the reverse of the procedure.

To replace the battery, insert screwdriver under the frontmost ventilation slot (F) and prize off the battery cover (D) and pull the battery ribbon to lift the battery (E) from the MC464. Replacing is the reverse of the procedure.

## LCD DISPLAY



Display at start-up



Display with WDOG on

The IP address and subnet mask of the MC464 is shown on the LCD display for a few seconds after power-up. The factory default IP address is 192.168.0.250. This can be changed using the ETHERNET command via *Motion Perfect*.

## SOFTWARE

Trio recommend that you use the latest version of *Motion Perfect* 3 when using the MC464 (Minimum recommended version MPv3\_0\_1\_4725). Software can be downloaded from [www.triomotion.com](http://www.triomotion.com).

## MODULE ASSEMBLY

A maximum of 7 half height modules or 3 full height modules may be fitted to the MC464. A system may be made using any combination of half and full height modules providing that the full height modules are the last to be attached.

## MODULE SLOT NUMBERS

SLOT Numbers are allocated by the system software in order, left to right, starting with the lower bus. Lower modules are allocated slots 0 to m, then the upper modules become slots m+1 to n. Finally, the Sync Encoder Port is allocated slot n+1. The Sync Encoder Port has SLOT number -1 in addition to the one allocated (1) in this sequence.

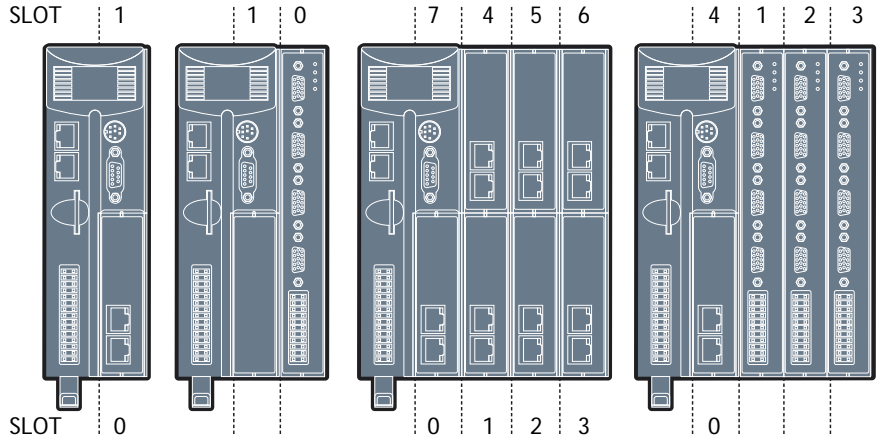

## EXPANSION MODULE P871 - MC464 PANASONIC INTERFACE

### REGISTRATION CONNECTOR

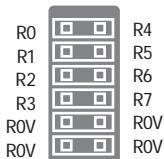
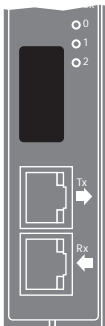

R0 - R7: registration inputs (24V).  
R0V: registration common 0V return.

Registration inputs can be allocated to any axis by software.

Note: This pin out applies to module serial numbers P871-00011 and higher.

### RJ45 CONNECTOR (TX)

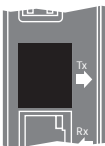

100Mbps Panasonic "Realtime Express" transmit - connect to receive of first drive.

### RJ45 CONNECTOR (RX)

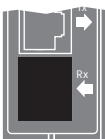

100Mbps Panasonic "Realtime Express" receive - connect to transmit of last drive.



## LED FUNCTIONS

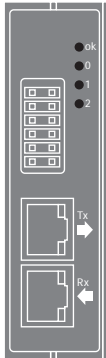

LED	LED Colour	LED Function
ok	Green	ON=Module Initialised Okay
0	Red	ON=Module Error
1	Yellow	Status 1
2	Yellow	Status 2

## EXPANSION MODULE P872 - MC464 SERCOS INTERFACE

### REGISTRATION CONNECTOR

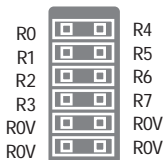

R0 - R7: registration inputs (24V).  
0V: registration common 0V return.

Registration inputs can be allocated to any axis by software.

### CONNECTOR (TX)

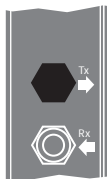

9mm FSMA

sercos fibre-optic transmit.

### CONNECTOR (RX)

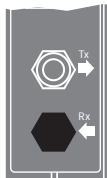

9mm FSMA

sercos fibre-optic receive.

## LED FUNCTIONS

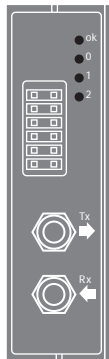

LED	LED Colour	LED Function
ok	Green	ON=Module Initialised Okay
0	Red	ON=Ring Open / Distorted
1	Yellow	SERCOS Phase
2	Yellow	SERCOS Phase

SERCOS PHASE	LED 1	LED 2
0	OFF	FLASH
1	OFF	ON
2	FLASH	OFF
3	ON	OFF
4	ON	ON

## EXPANSION MODULE P873 - MC464 SLM INTERFACE

### REGISTRATION CONNECTOR

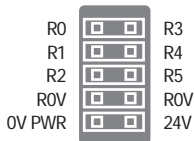

R0 - R5: registration inputs (24V).

0VR: common 0V return.

0V PWR: } Power input for SLM system.

24V: }

### SLM CONNECTOR



15 Way D-Type

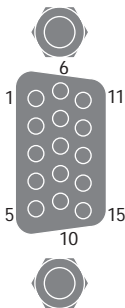

Pin	Upper D-Type	Lower D-Type
1	Com Axis 0	Com Axis 3
2	/Com Axis 0.	/Com Axis 3
3	Hardware Enable	Hardware Enable
4	0V Output	0V Output
5	24V Output	24V Output
6	Com Axis 1	Com Axis 4
7	/Com Axis 1	/Com Axis 4
8	No Connection	No Connection
9	No Connection	No Connection
10	No Connection	No Connection
11	24V Output	24V Output
12	0V Output	0V Output
13	Com Axis 2	Com Axis 5
14	/Com Axis 2	/Com Axis 5
15	Earth / Shield	Earth / Shield

## LED FUNCTIONS



LED	LED Colour	LED Function
ok	Green	ON=Module Initialised Okay
0	Red	ON=Module Error
1	Yellow	Status 1
2	Yellow	Status 2

## EXPANSION MODULE P874 / P879 - MC464 FLEXIBLE AXIS INTERFACE

### REGISTRATION CONNECTOR



V0V		V0V
V0V		V0V
V0		V4
V1		V5
V2		V6
V3		V7
R0		R4/PS4
R1		R5/PS5
R2		R6/PS6
R3		R7/PS7
0V PWR		24V

V0 - V7: Voltage outputs  
 R4/PS4 - R7/PS7: Bidirectional registration  
 R0 - R3: Registration In  
 Inputs / 24V: PSwitch outputs  
 0V PWR: Power Input  
 24V: Power Input  
 V0V: DAC common 0V return

NOTE: 4 axis version uses voltage outputs  
 0 - 3 only.

### LED FUNCTIONS

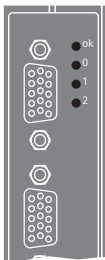

LED	LED Colour	LED Function
ok	Green	ON=Module Initialised Okay
0	Red	ON=Module Error
1	Yellow	Status 1
2	Yellow	Status 2

## ENCODER CONNECTOR

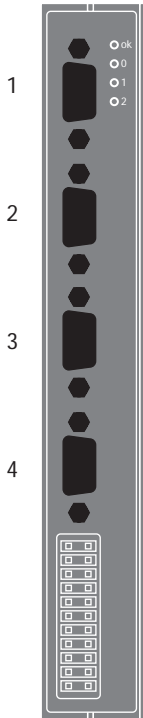

### 15 Way D-Type

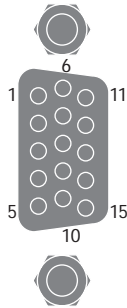

Pin	Incremental Encoder	Absolute Encoder	Pulse & Direction
1	Enc. A n	Clock n	Step.+ n
2	Enc. /A n	/Clock n	Step.- n
3	Enc. B n	-----	Direction+ n
4	Enc. /B n	-----	Direction- n
5	0V Enc.	0V Enc.	0V Step.
6	Enc. Z n	Data n	Enable+ n
7	Enc. /Z n	/Data n	Enable- n
8	5V*	5V*	5V*
9	Enc. A n+4	Clock n+4	Step.+ n+4
10	Enc. /A n+4	/Clock n+4	Step.- n+4
11	Enc. B n+4	-----	Direction+ n+4
12	Enc. /B n+4	-----	Direction- n+4
13	Enc. Z n+4	Data n+4	Enable+ n+4
14	Enc. /Z n+4	/Data n+4	Enable- n+4
15	0V Enc.	0V Enc.	0V Enc.

Connector	8 Axes (P874)	4 Axes (P879)
1	0 and 4	0
2	1 and 5	1
3	2 and 6	2
4	3 and 7	3

\*5V supply is limited to 150mA per axis.

Absolute Encoder is only available on axes 4 - 7 on P874 and 2 - 3 on P879.

## EXPANSION MODULE P875 - MC464 ANYBUS® INTERFACE

### ANYBUS® FITTING

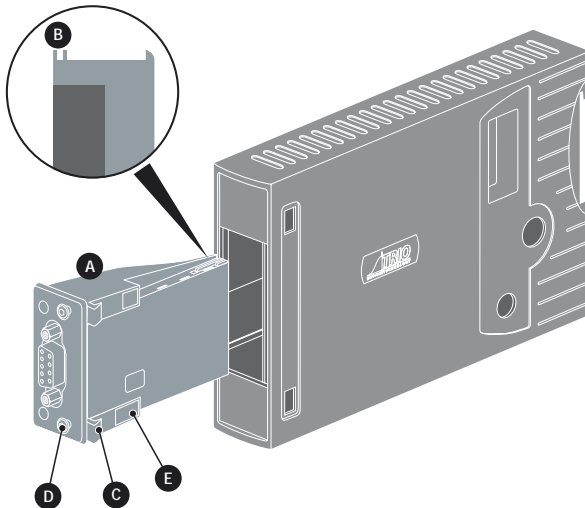
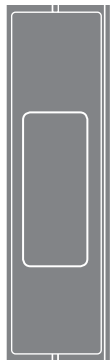

Push the Anybus® module (A) into the Trio Expansion Interface taking care to keep its base in contact with the PCB and align guide slots (B) with the connector rails inside. Ensure that the moulded hooks (C) on the lower front edge of the Anybus® module locate under the P875 PCB at the front.

When the module is flush with the face of the Trio Expansion Interface, tighten the two “Torx” head screws (D) to locate the two lugs (E) and secure the Anybus® module.

To remove the module, reverse this procedure.



## EXPANSION MODULE P876 - MC464 ETHERCAT INTERFACE

### REGISTRATION CONNECTOR

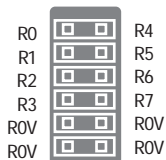

R0 - R7: registration inputs (24V).  
0V: registration common 0V return.

Registration inputs can be allocated to any axis by software.

### RJ45 CONNECTOR

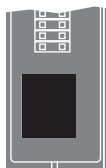

100 base-T Ethernet master. Connect to IN of first drive.

## LED FUNCTIONS

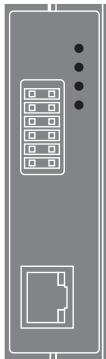

LED	LED Colour	LED Function
ok	Green	ON=Module Initialised Okay
0	Red	ON=Module Error
1	Yellow	Status 1
2	Yellow	Status 2



Trio Motion Technology Ltd.

Trio Motion Technology LLC.

Trio Shanghai

Trio India

Website: [www.triomotion.com](http://www.triomotion.com)